

◎ INJECTION PRESS RANGE: 80-350 TON ◎

Digital AC SERVO Robot Series

LW-1000VII

LWS-1000VII

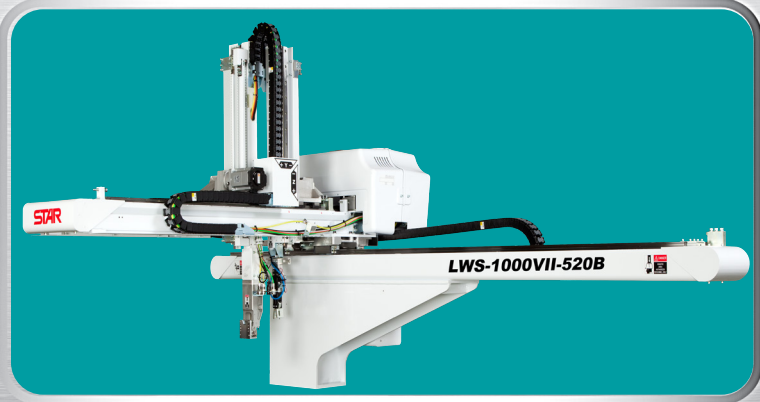

COMMON SPECIFICATIONS

Power Source	Air Pressure	Drive	Posture (air cylinder)	Recommended Max Load	Posture Torque @ 70 PSI	Control Types
200 VAC ± 10% 60 Hz	70 psi (.48 MPa)	AC Servo Motor	90°	11 lbs (5 kg)	14.9 ft-lbs (20.2 N·m)	STEC-520B

GENERAL SPECIFICATIONS

Model	Stroke				Electric Consumption (kVA)	Max Power Consumption (kW)	Main Body Weight (KG)	Air Consumption (ft³)
	(P) Vertical	(R) Vertical	Crosswise	Traverse				
LW-1000VII	41.33" (1050 mm)	N/A	30.32" (770 mm)	70.87" (1800 mm)	2.9	1.7	354 (780 lbs)	0.079 (2.2 NI / Cycle)
LWS-1000VII	41.33" (1050 mm)	41.33" (1050 mm)	26.6" (675 mm)	70.87" (1800 mm)	3.5	2.1	396 (873 lbs)	0.084 (2.4 NI / Cycle)

STANDARD FEATURE

Vacuum Generator with Part Present Sensor
Part Grip Circuit
Sprue Grip Circuit
USB Port
Ethernet Port
Sample and Chuck Change Positons
Product Packaging (256 each axis)
CNC Step Programming
Micro SD
CPC® and AMP® Connections at the Head
Active Vibration Control
IMM Mounting Weldment
Multi- Level Password Protection
Position, Speed and Timer Adjust in Auto
Alarm History
Grease Pocket LM Bearings

OPTION LIST

Additional Vacuum Generator with Part Present Sensor
Additional Part Grip
Nipper on Chuck
Rotation 90°, 180° 2-Position, 180° 3-Position
Shuttle on Tool
Mold Spray
Air Blow
1-3 Color Alarm Light
Special Paint
Free Packaging
Central Lube
Quick Chuck Change
Servo Posture Wrist
Servo Posture Rotate

OVERALL DIMENSIONS

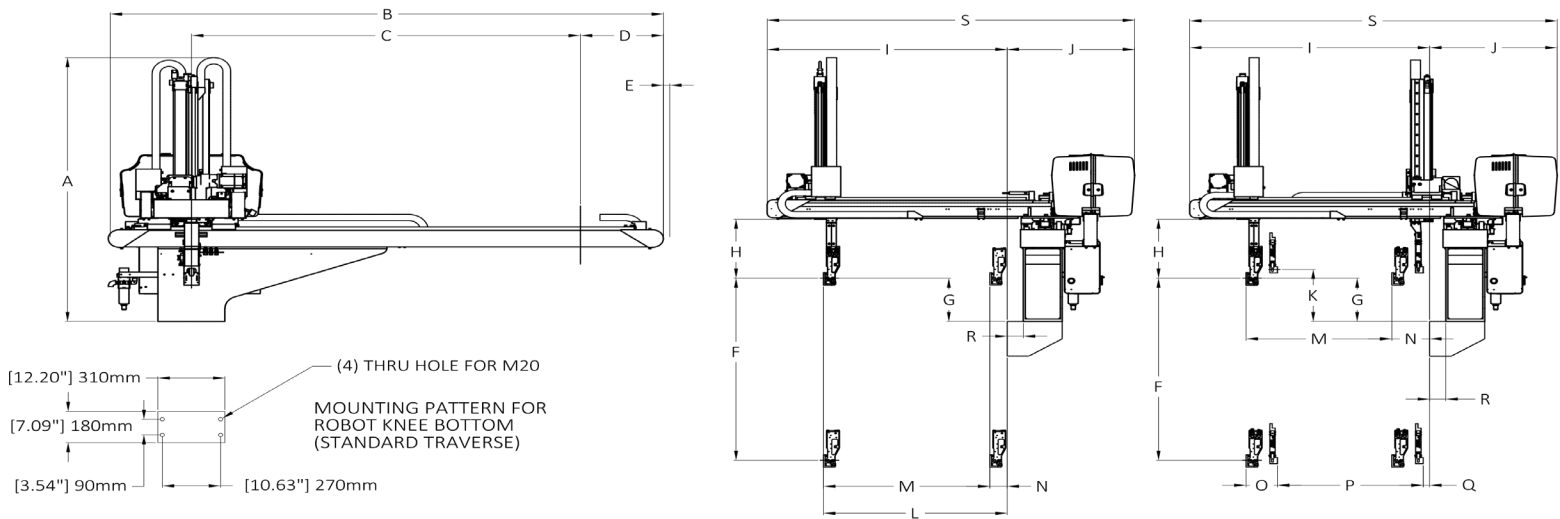

		LW-1000VII	LWS-1000VII
A	Overall Height	59.92" (1522mm)*	59.92" (1522mm)*
B	Overall Width	101.22" (2571mm)	101.22" (2571mm)
C	Traverse Stroke	70.87" (1800mm)	70.87" (1800mm)
D	Overhang, Release Side	15.20" (386mm)	15.20" (386mm)
E	Cable Guide Overhang	0	0
F	(P) Vertical Stroke	41.33" (1050mm)	41.33" (1050mm)
G	(P) Vertical Standby	9.84" (250mm)	9.84" (250mm)
H	Bottom of Crosswise to Chuck Mount Postion	13.38" (340mm)	13.38" (340mm)
I	Mold Mounting Face - Crosswise Arm End	43.74" (1111mm)	43.74" (1111mm)
J	Mold Mounting Face - Box End	23.23" (590mm)	23.23" (590mm)
K	(R) Vertical Standby	-	11.81" (300mm)
L	(P) Crosswise Reach Max.	33.46" (850mm)	33.46" (850mm)
M	(P) Crosswise Stroke Max.	30.32" (770mm)	26.57" (675mm)
N	(P) Crosswise Standby Min.	3.15" (80mm)	6.89" (175mm)
O	(P) Proximity Min.	-	5.71" (145mm)
P	(R) Crosswise Stroke Max.	-	26.57" (675mm)
Q	(R) Crosswise Standby Min.	-	1.18" (30mm)
R	Base Offset	2.95" (75mm)	2.95" (75mm)
S	Box End - Crosswise Arm End	66.97" (1701mm)	66.97" (1701mm)

*Some units may be 15mm taller
All stated here is subject to change without notice



Wisconsin (HQ)

N90 W14401 Commerce Drive
Menomonee Falls, WI 53051
Phone: 262-253-3550
Fax: 262-253-3559
Email: kscheife@starautomation.com

California

18141 Beach Blvd, Unit 195
Huntington Beach, CA 92648
Phone: 714-375-2400
Fax: 714-375-2446
Email: ryamasaki@starautomation.com

Georgia

5555 Oakbrook Parkway Suite 320
Norcross, GA 30093
Phone: 770-582-9350
Fax: 770-582-9351
Email: chebert@starautomation.com

Indiana

5625 Vogel Road Unit B
Evansville, IN 47715
Phone: 812-475-9947
Fax: 812-475-9949
Email: sberry@starautomation.com

Michigan

17197 North Laurel Park Dr. Suite 125
Livonia, MI 48152
Phone: 734-462-9522
Fax: 734-462-9527
Email: tsukuda@starautomation.com

Rhode Island

860A Waterman Avenue
E Providence, RI 02914
Phone: 401-434-0617
Fax: 401-434-0627
Email: sales@starautomation.com

Tennessee

Sales Phone: 678-428-4202
Service Phone: 615-796-5670
Email: chebert@starautomation.com

Star Seiki Mexico S.A. De C.V.

Blvd Bernardo Quintana #7001
Torre II Oficina 1004 Colonia Centro Sur,
Queretaro, CP. 76090 Mexico
Phone: +52-442-199-5180
Email: knomura@starseikimexico.com